

880nm 3W 单管

应用范围

- 医疗照射
- 目标指示
- 激光显示
- 舞台灯光

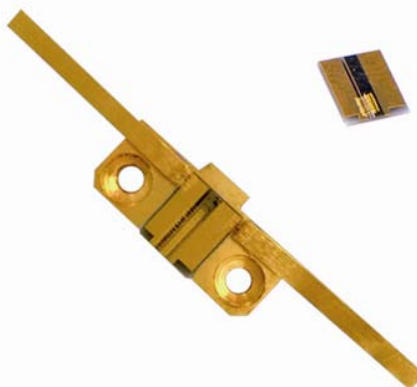

技术指标 (20°C)

COS/F 封装单管			
参 数		单 位	LDMC-0880-003W-*5
光学参数	输出功率	W	3
	激射波长	nm	880±10
	光谱宽度	nm	≤ 3
	发光区宽度	μm	150
	温漂系数	nm/°C	0.30
	快轴发散角	deg	< 40
	慢轴发散角	deg	< 10
电学参数	斜率效率	W/A	≥ 1.03
	阈值电流	A	≤ 0.50
	工作电流	A	≤ 3.30
	工作电压	V	< 2.00
热学参数	工作温度	°C	15 ~ 30
	存储温度	°C	-40 ~ 60
	焊接温度	°C	≤ 260
封装形式	COS/F-Package		



封装外形图

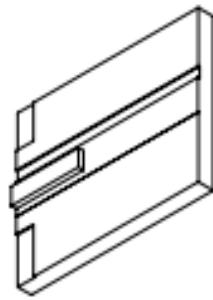
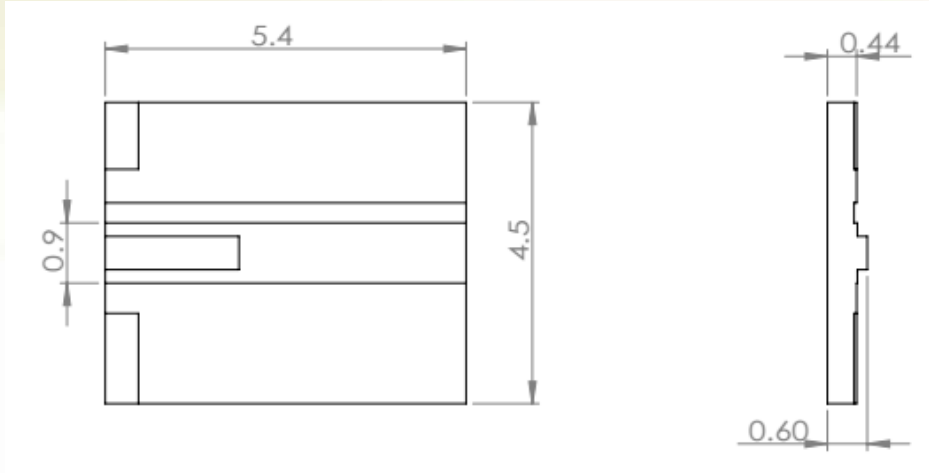

COS 封装

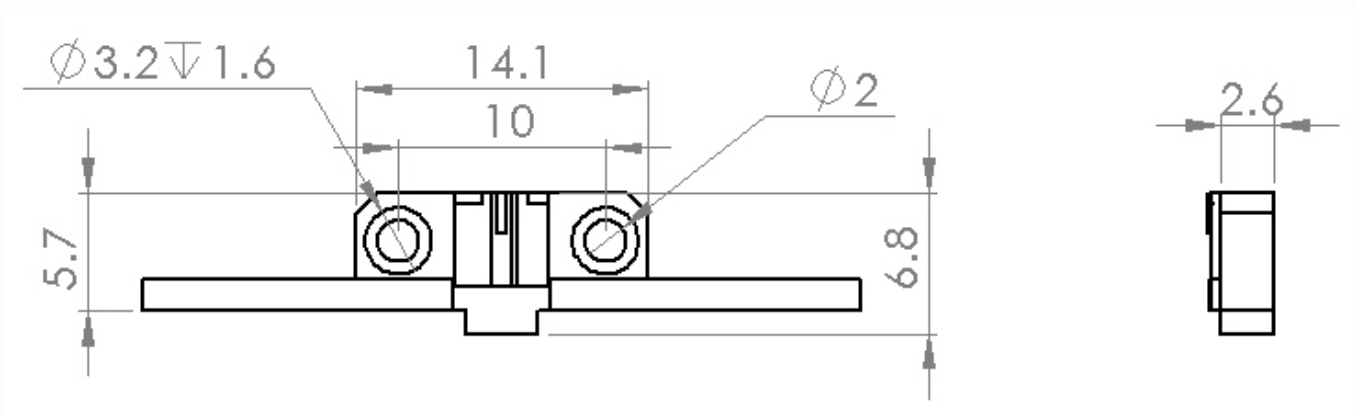

F 封装





海特光电有限责任公司
Hi-Tech Optoelectronics Co.,Ltd.

- 1、产品型号说明：LDM (产品类型) -**** (中心波长) -**** (输出功率) -** (热沉结构及产品条宽)。
- 2、表格中参数均为封装在 C-Mount 热沉上测试所得。
- 3、如有更多信息需求请联系海特光电有限责任公司。



地址：北京市昌平区沙河工业园区海特光电有限责任公司
电话：010-60769887/72 传真：010-60769887-699
网址：www.htoe.com.cn 邮箱：sales@htoe.com.cn

